



McIntosh Laboratory, Inc. 2 Chambers Street Binghamton, New York 13903-2699 Phone: 607-723-3512 [www.mcintoshlabs.com](http://www.mcintoshlabs.com)

MT5  
Precision Turntable  
Owner's Manual



The lightning flash with arrowhead, within an equilateral triangle, is intended to alert the user to the presence of uninsulated “dangerous voltage” within the product’s enclosure that may be of sufficient magnitude to constitute a risk of electric shock to persons.

**WARNING - TO REDUCE RISK OF FIRE OR ELECTRICAL SHOCK, DO NOT EXPOSE THIS EQUIPMENT TO RAIN OR MOISTURE.**

## IMPORTANT SAFETY INSTRUCTIONS!

### PLEASE READ THEM BEFORE OPERATING THIS EQUIPMENT.

1. Read these instructions.
2. Keep these instructions.
3. Heed all warnings.
4. Follow all instructions.
5. Do not use this apparatus near water.
6. Clean only with a dry cloth.
7. Do not block any ventilation openings. Install in accordance with the manufacturer’s instructions.
8. Do not install near any heat sources such as radiators, heat registers, stoves, or other apparatus (including amplifiers) that produce heat.
9. Do not defeat the safety purpose of the polarized or grounding-type plug. A polarized plug has two blades with one wider than the other. A grounding type plug has two blades and a third grounding prong. The wide blade or the third prong are provided for your safety. If



**AVIS** RISQUE DE CHOC ELECTRIQUE - NE PAS OUVRIR.  
**NO USER-SERVICEABLE PARTS INSIDE. REFER SERVICING TO QUALIFIED PERSONNEL.**

the provided plug does not fit into your outlet, consult an electrician for replacement of the obsolete outlet.

10. Protect the power cord from being walked on or pinched particularly at plugs, convenience receptacles, and the point where they exit from the apparatus.
11. Only use attachments/accessories specified by the manufacturer.
12. Use only with the cart, stand, tripod, bracket, or table specified by the manufacturer, or sold with the apparatus. When a cart is used, use caution when moving the cart/apparatus combination to avoid injury from tip-over.
13. Unplug this apparatus during lightning storms or when unused for long periods of time.
14. Refer all servicing to qualified service personnel. Servicing is required when the apparatus has been damaged in any way, such as power-supply cord or plug is damaged, liquid has been spilled or objects have fallen into the apparatus, the apparatus has been exposed to



The exclamation point within an equilateral triangle is intended to alert the user to the presence of important operating and maintenance (servicing) instructions in the literature accompanying the appliance.

**To prevent the risk of electric shock, do not remove cover or back. No user-serviceable parts inside.**

**WARNING: Use this product only with the Power Adapter provided. Failure to do so may result in fire and/or electrical shock.**

- rain or moisture, does not operate normally, or has been dropped.
15. Do not expose this equipment to dripping or splashing and ensure that no objects filled with liquids, such as vases, are placed on the equipment.
16. To completely disconnect this equipment from the a.c. mains, disconnect the AC / DC Adapter from the a.c. receptacle.
17. The mains plug of the power supply cord shall remain readily operable. If the AC /DC Adapter is provided with a mains power supply cord attachment, the plug of this power supply cord shall remain readily operable.
18. Do not expose batteries to excessive heat such as sunshine, fire or the like.
19. Connect mains power supply cord only to a mains socket outlet with a protective earthing connection.

---

## Thank You

Your decision to own this McIntosh MT5 Precision Turntable and Sumiko BP2 High Output Moving Coil Cartridge ranks you at the very top among discriminating music listeners. You now have “The Best.” The McIntosh dedication to “Quality,” is assurance that you will receive many years of musical enjoyment from this unit. Please take a short time to read the information in this manual. We want you to be as familiar as possible with all the features and functions of your new McIntosh.

## Please Take A Moment

The serial number, purchase date and McIntosh Dealer name are important to you for possible insurance claim or future service. The spaces below have been provided for you to record the information:

Serial Number: \_\_\_\_\_

Purchase Date: \_\_\_\_\_

Dealer Name: \_\_\_\_\_

## Technical Assistance

If at any time you have questions about your McIntosh product, contact your McIntosh Dealer who is familiar with your McIntosh equipment and any other brands that may be part of your system. If you or your Dealer wish additional help concerning a suspected problem, you can receive technical assistance for all McIntosh products at:

McIntosh Laboratory, Inc.  
2 Chambers Street  
Binghamton, New York 13903  
Phone: 607-723-1545  
Fax: 607-724-0549

## Customer Service

If it is determined that your McIntosh product is in need of repair, you can return it to your Dealer. You can also return it to the McIntosh Laboratory Service Department. For assistance on factory repair return procedure, contact the McIntosh Service Department at:

McIntosh Laboratory, Inc.  
2 Chambers Street  
Binghamton, New York 13903  
Phone: 607-723-3515  
Fax: 607-723-1917

## Table of Contents

Safety Instructions .....	2
Thank You and Please Take a Moment.....	3
Technical Assistance and Customer Service .....	3
Table of Contents .....	3
General Information .....	4
Connector and Cable Information .....	4
Introduction.....	5
Performance Features .....	5
Dimensions .....	6
Unpacking the Turntable.....	7
Assembling the Turntable .....	8-11
Installing a non-supplied Cartridge and Tone Arm Adjustments .....	11-13
Rear Panel Connections and Adjustments .....	14
How to Connect the Turntable .....	15
Front Panel Display, Switches, Lever and Record Clamp.....	16
How to Operate the Turntable.....	17
Specifications.....	18
Packing Instruction.....	19

## General Information

**Caution:** To prevent possible damage to the turntable platter bearing, do not move the MT5 Precision Turntable with the platter installed.

- For additional connection information, refer to the owner's manual(s) for any component(s) connected to the MT5 Precision Turntable.
- The MT5 Precision Turntable comes with the Sumiko BP2 High Output Moving Coil Cartridge.
- It is recommended the Professionals at your McIntosh Dealer, who are skilled in all aspects of Turntables and Phono Cartridges, install the MT5 Precision Turntable and any associated audio equipment.
- For optimum performance, the setup and adjustment of the MT5 Precision Turntable requires special test recordings and test/measurement equipment. Contact your McIntosh Dealer for additional information and assistance.
- The MT5 Precision Turntable is supplied with the Sumiko Blue Point 2 High Output Moving Coil Cartridge. It is designed to playback 33-1/3 rpm and 45 rpm vinyl recordings. If you would like to also playback 78 rpm recordings, the McIntosh MCC10 Moving Coil Cartridge has the ability to playback records of all three speeds. Contact your McIntosh Dealer for additional information and assistance.
- When discarding the unit, comply with local rules or regulations. Batteries should never be thrown away or incinerated but disposed of in accordance with the local regulations concerning battery disposal. 
- For additional information on the MT5 and other McIntosh Products please visit the McIntosh Web Site at [www.mcintoshlabs.com](http://www.mcintoshlabs.com).

- When an AC Line Cord is used to connect the supplied AC / DC Adapter to an AC Outlet, it is important the line cord conductor size is a minimum 0.75mm<sup>2</sup> for each leg of the two conductor cord.
- If it should become necessary to replace the supplied AC / DC Adapter and/or the plug adapters, order part number 320508SP from the McIntosh Parts Department. Refer to the illustration below.



## Connector and Cable Information

### Power Control Connectors

The Power Control Output Jack sends Power On/Off Signals (+12 volt/0 volt) when connected to other McIntosh Components. An additional connection is for controlling the illumination of the Power Output Meters on McIntosh Power Amplifiers. A 3.5mm stereo mini phone plug is used for connection to the Power Control jacks.

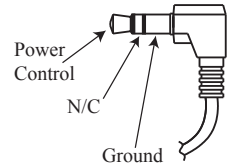

### Tonarm Headshell Wiring

Refer to the following list of wire colors in the headshell for installing the cartridge into the Headshell:

<u>Cartridge Connections</u>	<u>Headshell Wire Color</u>
Left Channel (+)	White
Left Channel (-)	Blue
Right Channel (+)	Red
Right Channel (-)	Green

### Sumiko BP2 Cartridge Connections

Refer to the following illustration when connecting the McIntosh Cartridge in the Headshell:

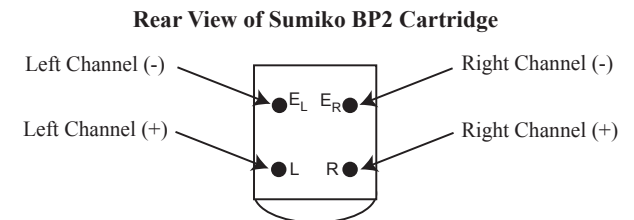

### Introduction

The McIntosh MT5 Precision Turntable with the Sumiko BP2 High Output Moving Coil Cartridge offers the latest in playback of vinyl recordings. A full complement of performance features allow for the enjoyment of all recordings reproduced with flawless realism. The advanced electronic and mechanical design ensures many years of smooth trouble free operation.

### Performance Features

#### • **Advanced Technology Turntable**

The MT5 combines the latest technology in Phono Cartridges, Tone Arms, Mechanical Suspensions and Record Platter Rotation for superb performance and accurate operation.

#### • **Moving Coil Cartridge**

The Sumiko BP2 High Output Moving Coil Cartridge has the inherent correctness of the impeccable mechanical and electrical design. High impedance, together with high output voltage, ensures noise free musical reproduction. This unique high output design features an alloy cantilever, elliptical diamond stylus with exceptional tracking capability. The ruler-flat frequency response from 20Hz to 20kHz provides solid realistic bass, uncolored midrange and natural high frequencies.

#### • **Tone Arm**

The MT5 Tone Arm is made from Dural-Aluminum with special damping material. The Tone Arm is both light in weight and highly rigid. The noise free Vertical Bearings are made from two high precision ceramic surfaces. The Tone Arms lateral movement is performed by a high precision Horizontal Bearing. It also incorporates adjustable magnetic Anti-Skating.

#### • **Turntable Platters**

The full size Outer Platter is made from a special silicone acrylic material weights five pounds, one and one-half inch thick. This helps to resist external vibrations from reaching the record during playback and its large mass provides the perfect flywheel action for stable playback speed. The inner platter is precision machined Anodized Aluminum weights one and one-half pounds and is six and one quarter inches in diameter.

#### • **Precision Motor and Drive Electronics**

The Swiss made DC Motor has stainless steel brushes and is controlled by a highly refined servo control system assuring very accurate speed rotation.

#### • **Three Playback Speeds with fine Adjustments**

The three playback speeds include 33 rpm, 45 rpm and 78 rpm. There is a separate trim adjustment allowing for accurate music reproduction for each of the three speeds.

#### • **Magnetic Air Dampened Bearing**

The MT5 Turntable Platter rotates on a ceramic bearing using magnetic suspension together with a cushion of air to provide vibration free rotation.

#### • **Multi-Layered Dampened Chassis**

The MT5 Turntable Chassis has a Stainless Steel base, with a thick Aluminum base plate and Acrylic top plate. The internal dampening material also helps to assure the only sound heard is from the record groove itself.

#### • **Power Control**

The Power Control Input connection provides convenient Turn-On/Off of the MT5 Illumination when connected to a McIntosh System with Power Control.

#### • **Fiber Optic Solid State Illumination**

The even Illumination of the Front Panel and the Turntable Platter is accomplished by the combination of custom designed Fiber Optic Light Diffusers and extra long life Light Emitting Diodes (LEDs).

#### • **Glass Front Panel and Super Mirror Chassis Finish**

The famous McIntosh Illuminated Glass Front Panel and the Stainless Steel Chassis with Super Mirror Finish ensures the pristine beauty of the MT5 will be retained for many years.

**Dimensions**

The following dimensions can assist in determining the best location for your MT5.

**Front View of the MT5**

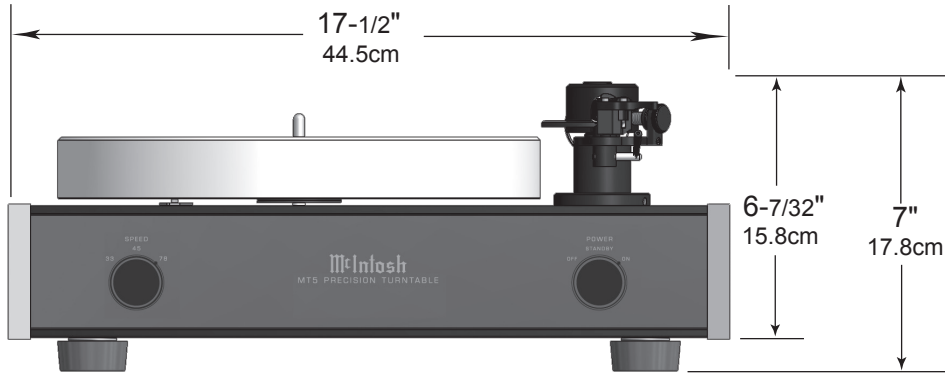

*Note: The height measurements are with the Blue Point 2 Cartridge installed.*

**Rear View of the MT5**

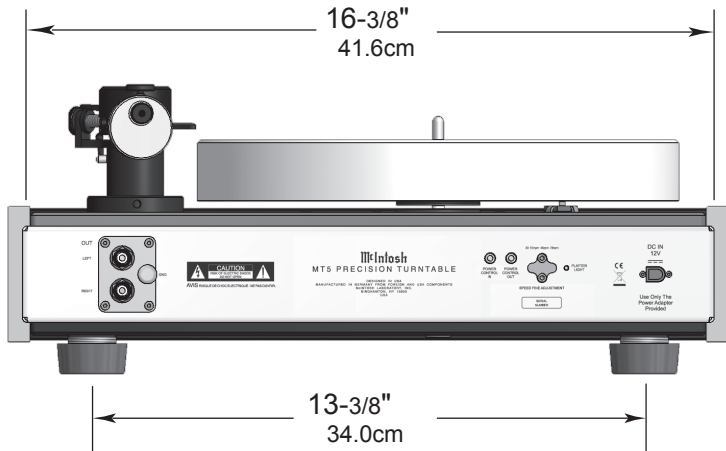

**Side View of the MT5**

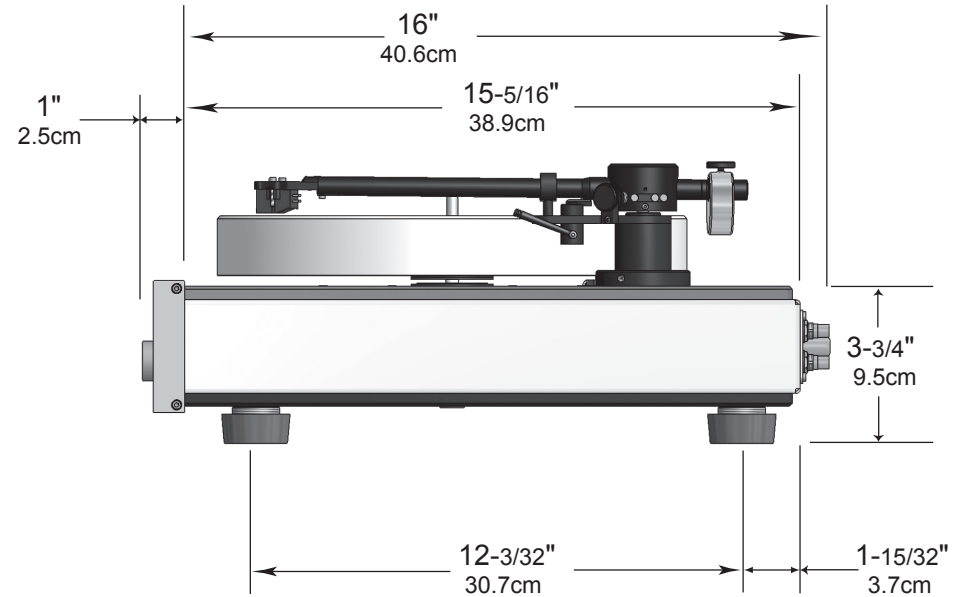

## Unpacking the Turntable

To protect the fine finish of the MT5 Precision Turntable during the assembly and adjustment process, it is advisable to prepare a suitable clean working area with a soft, clean fabric, such as a bed linen or blanket.

It is recommended that the Professionals at your McIntosh Dealer, who are skilled in all aspects of installation and operation, unpack, assemble, adjust and install the MT5 Precision Turntable.

**CAUTION: To prevent possible damage to the turntable platter bearing, do not move the MT5 Precision Turntable after the Inner/Outer Platters are installed.**

1. Referring to the illustration on the right, open the shipping carton and carefully remove the following items from the carton and place them in the previously prepared working area:
  - A. Owner's Manual Pack with Tone Arm/Cartridge Alignment Gauge
  - B. Record Mat
  - C. Dust Cover
  - D. Inner Platter
  - E. Tonearm Counter Weight
  - F. Record Clamp
  - G. AC/DC Adapter
  - H. Center Spindle
  - I. Turntable
  - J. Outer Platter
  - K. Accessories Pack containing the following:
    1. Pair of gloves
    2. Belt
    3. Grounding Cable
    4. Bubble Level
    5. Bearing Oil
    6. AC Adapter Plugs
    7. Cartridge Mounting Screws
    8. Screw Driver and Allen Wrenches
2. Proceed to Assembly of the Turntable starting on the next page.

**CAUTION: To prevent possible damage to the Cartridge Stylus, DO NOT remove the Stylus Guard at this time.**

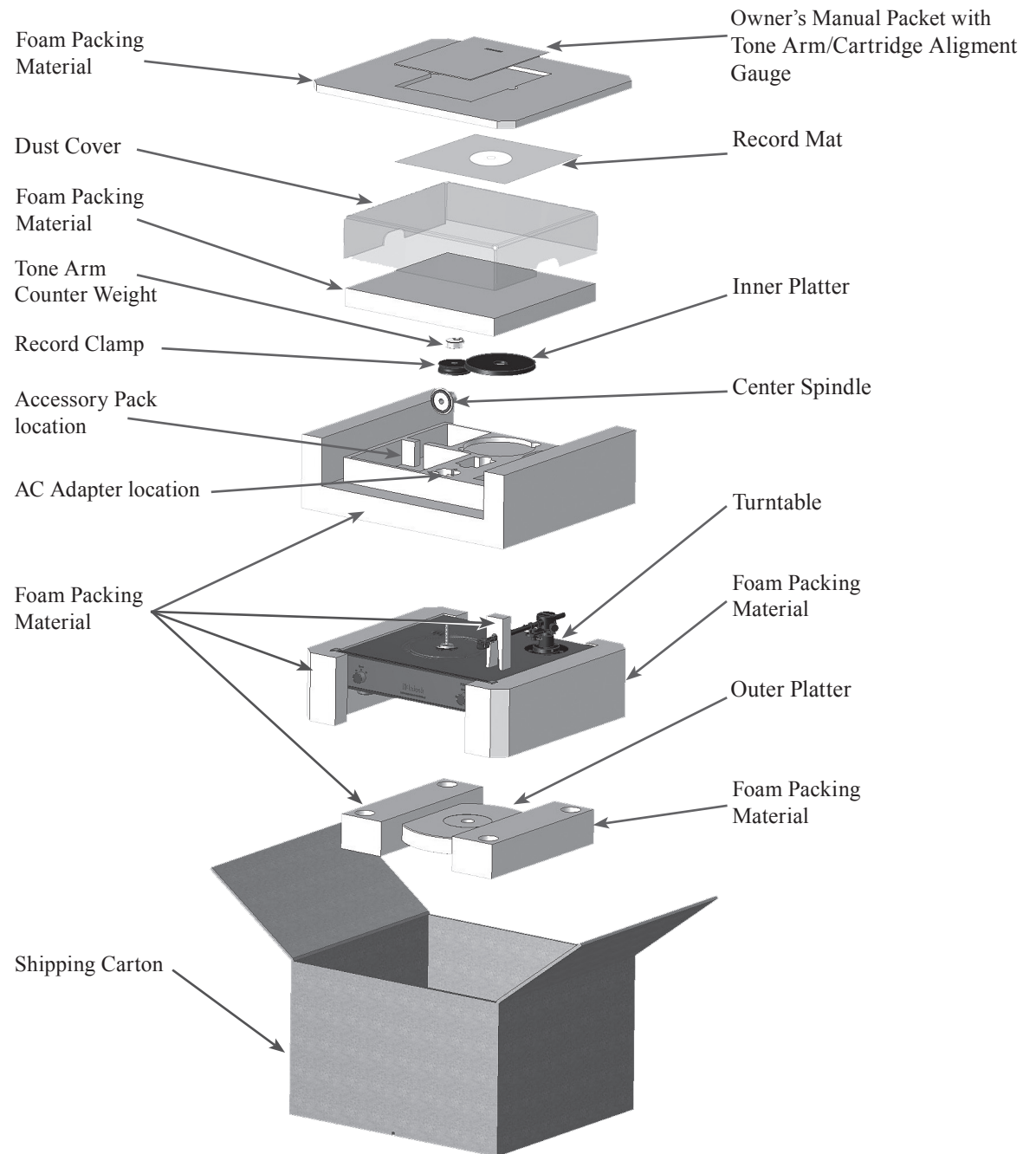

## Assembling the Turntable

Place the Turntable in the location where it will be used. Please keep in mind; the turntable should be the greatest possible distance from the system loudspeakers to reduce the chance of acoustic feedback. To minimize the possibility of the cartridge stylus jumping record grooves, place the turntable on a mechanically stable surface such as wall shelving anchored to wall studs. Perform the following assembly steps:

*Note: It is recommended the installation and adjustment of the McIntosh MT5 Precision Turntable be performed by the Professionals at your McIntosh Dealer.*

1. Remove the protective mesh from the Turntable Vertical Bearing Ceramic Shaft. Refer to figure 1.

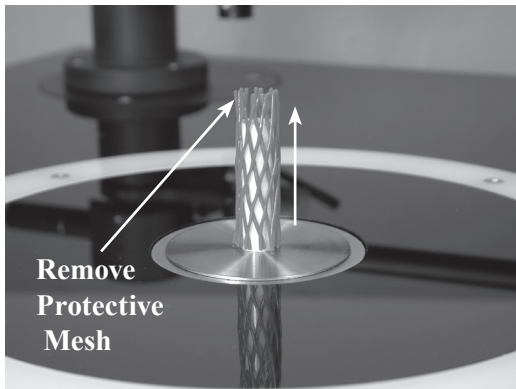

Figure 1

2. Locate the supplied Turntable Bearing Oil and place two small drops of Oil on the top sides of the Ceramic Vertical Bearing Shaft. Refer to figure 2.
3. Locate the Center Spindle and Inner Platter.
4. Place the bottom of the Center Spindle on the prepared flat surface. Line up the center opening

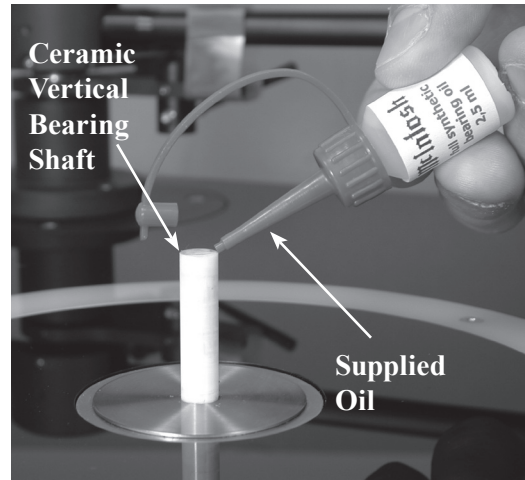

Figure 2

of the Inner Platter with the Center Spindle and carefully lower the Inner Platter onto the Center Spindle. Refer to figures 3, 4 and 5.

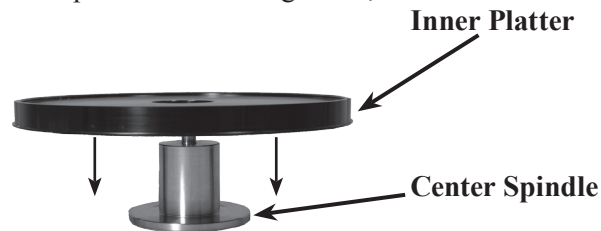

Figure 3



Figure 4

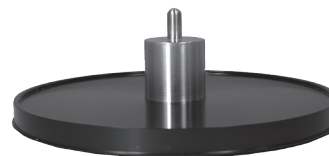

Figure 5

5. Invert the just assembled spindle/inner platter and remove the protective film from the bottom. Refer to figure 6.

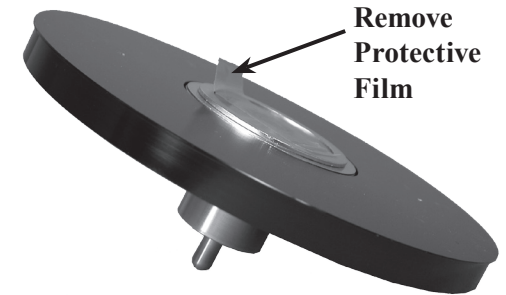

Figure 6

6. Very carefully lower the assembled spindle/inner platter onto the Ceramic Vertical Bearing Shaft, keeping the platter parallel with the top surface of the Turntable. Refer to figure 7.

*Note: The Ceramic Vertical Bearing Shaft of the McIntosh MT5 Precision Turntable is very durable in actual use, however it can be damaged during the assembly process if care is not taken.*

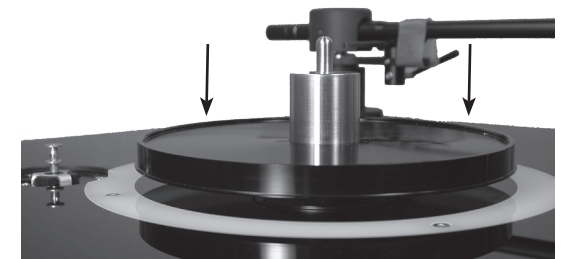

Figure 7

7. Using the supplied cloth gloves, place the belt onto the circumference of the inner platter and then onto the pulley of the motor. Rotate the inner platter by hand while seating the belt into it. Refer to figure 8.





Figure 8

8. Next, take the Outer Platter and slowly lower it onto the previously installed spindle/inner platter assembly making sure to keep the Outer Platter parallel to the Turntable surface as it is being lowered. Refer to figures 9 and 10.

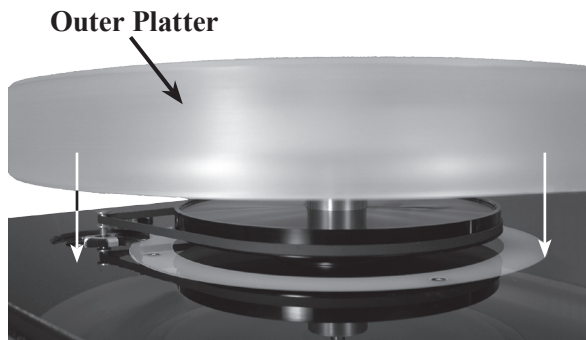

Figure 9

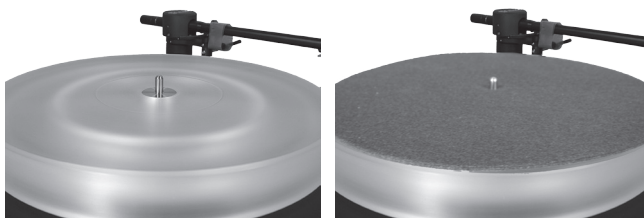

Figure 10

Figure 11

9. Locate the Record Mat and place it on top of the platter. Refer to figure 11.

10. Locate the McIntosh Bubble Level and place it on the Record Mat. If the Bubble is not in the center circle of the Bubble Level, adjust the height of the Turntable Feet (by rotating them clockwise or counter clockwise) until it is level. Refer to figures 12, 13 and 14.

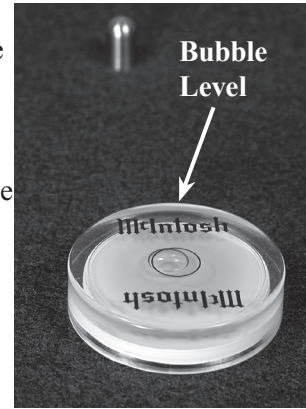

Figure 12

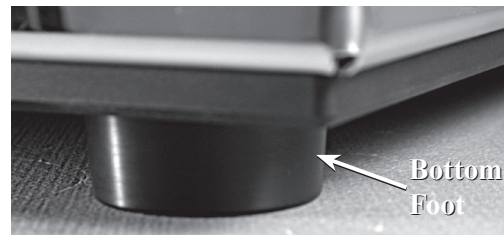

Figure 13

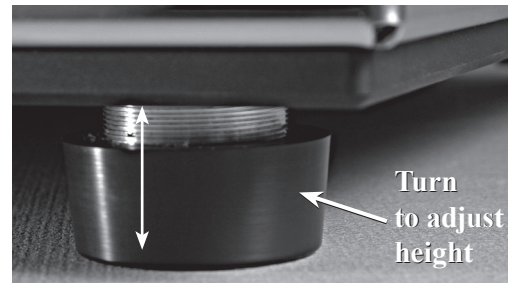

Figure 14

11. Locate the Tone Arm Counterweight. Loosen up the knurled knob to permit installing the Counterweight onto the rear of the Tone Arm. Refer to figure 15.

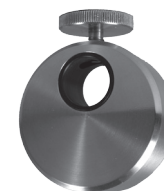

Figure 15

12. Position the Counterweight on the Tone Arm so the front surface of the Counterweight lines up with the Blue Point No. 2 Cartridge position marking on the surface at the rear of the Tone Arm. Tighten the knurled knob to secure the position of the Counterweight. Refer to figures 16, 17 and 18.

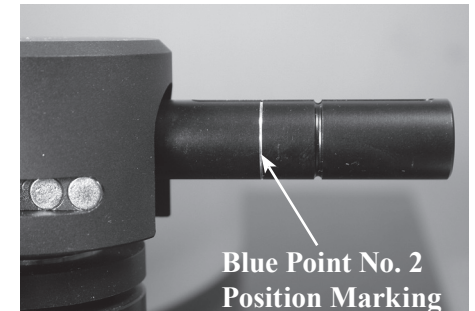

Figure 16

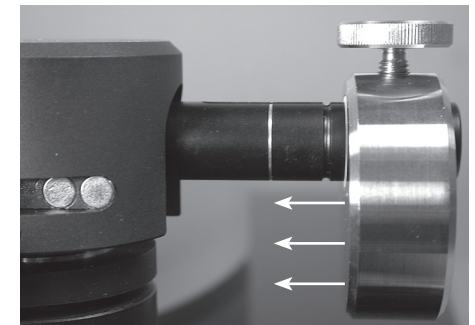

Figure 17



Figure 18

## Assembling the Turntable, con't

13. Remove the protective film material from the Tone Arm Rest Position. Refer to figures 19 and 20.

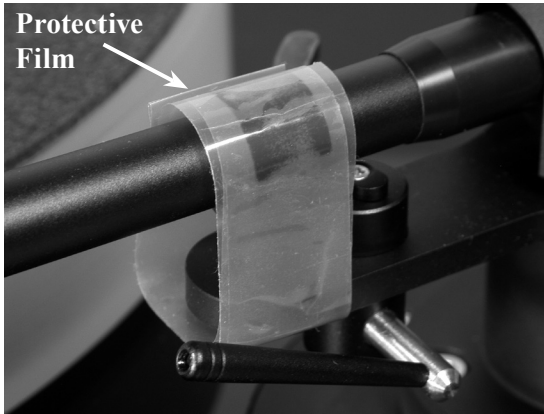

Figure 19

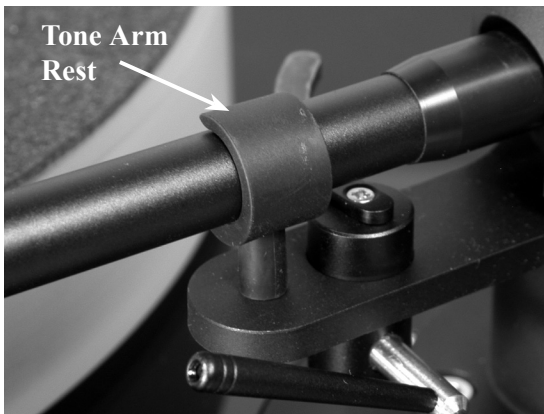

Figure 20

*Note: If another Phono Cartridge (such as the McIntosh MCC10) is to be used with the MT5 turntable, proceed to page 10 "Installing a non-supplied Cartridge" at this time.*

14. Carefully slide off the Stylus Guard from the cartridge by pulling the cover straight down. Refer to figures 21 and 22.

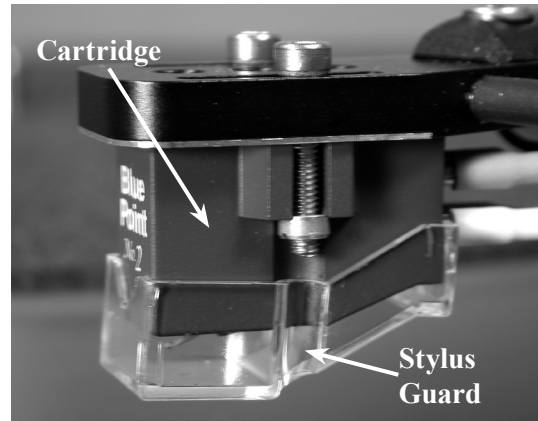

Figure 21

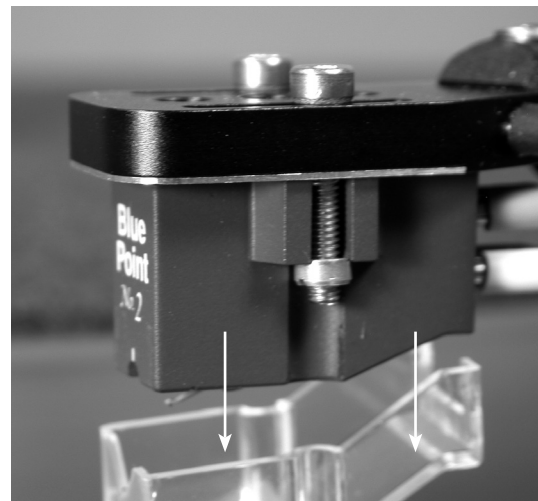

Figure 22

*Note: The Tracking Force Pressure, Anti-Skating and other adjustments have been preset at the factory for optimum performance. For additional information on setting Tracking Force Pressure, Anti-Skating and other adjustments refer to pages 11 thru 13.*

15. Proceed to "How to Connect the Turntable" on page 15.

## Installing a non-supplied Cartridge

**CAUTION:** To prevent possible damage to the turntable platter bearing, do not move the MT5 Precision Turntable with the platters installed.

In the event a non-supplied Phono Cartridge is to be installed into the McIntosh MT5 Turntable, please follow the steps below:

*Note: It is recommended that the Professionals at your McIntosh Dealer, who are skilled in all aspects of installation and adjustment of the McIntosh MT5 Precision Turntable, perform the assembly, installation and adjustments.*

1. Un-install the factory installed Phono Cartridge from the MT5 Tone Arm. First, place the Stylus Guard on the Cartridge. Carefully disconnecting the four push-on wire clips from the phono cartridge rear connection pins, using an appropriate tool. Then remove the mounting screws and nuts using the supplied allen wrench. Place the removed cartridge, spacer plate, screws and nuts in a safe place for possible future use. Refer to figures 23 and 24.

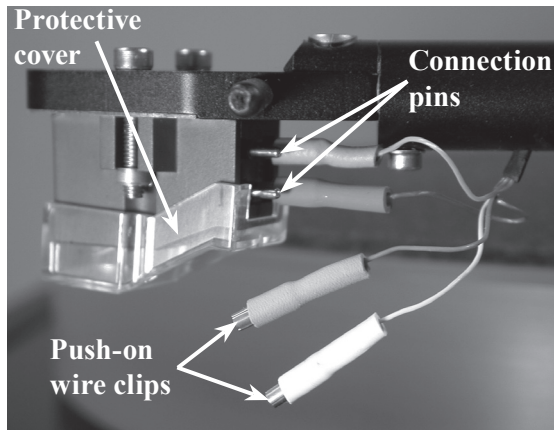

Figure 23

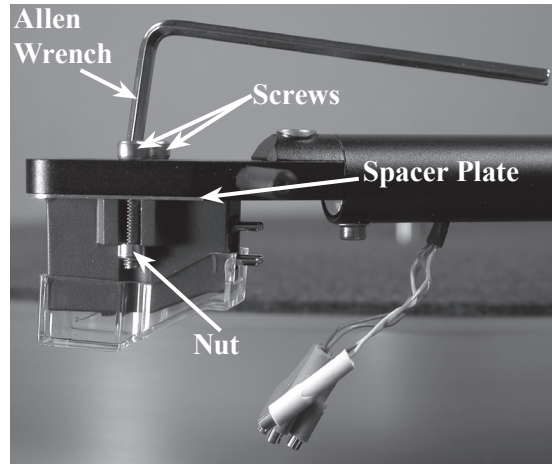

Figure 24

2. Locate the Hardware Package supplied with the new cartridge.
3. Using an appropriate tool, attach the four color coded wire lead connections coming from the front underside of the Tone Arm onto the rear of the new Phono Cartridge, following the instructions supplied with the Cartridge. Refer to figure 23. Below is the Tone Arm Headshell wire color lead identification:

### Wire Color

- Red - Right Channel Positive (+) Signal Connection
- Green - Right Channel Negative (-) Ground Connection
- White - Left Channel Positive (+) Signal Connection
- Blue - Left Channel Negative (-) Ground Connection

4. Position the Cartridge parallel to front and sides of the headshell and secure it with the supplied screws and nuts using the appropriate tools. Refer to figure 24.
5. Proceed to "Tone Arm Adjustments".

## Tone Arm Adjustments

### Phono Cartridge/Headshell Alignment

The MT5 Turntable Tone Arm, like all pivoting Tone Arms, follows a slight arc as it transverses across the surface of a phonograph record. By adjusting the distance between the horizontal pivot point of the Tone Arm and the Stylus Tip, the curvature of the arc can be minimized (sometimes referred to as the overhang adjustment). The Tone Arm Headshell of the MT5 Turntable allows for making this adjustment by positioning of the Phono Cartridge relative to the Headshell. Follow the steps below using the supplied McIntosh Tone Arm/Cartridge Alignment Gauge:

1. Place the Gauge over the center spindle post on the Platter and position the Gauge so the curved end is in contact with the horizontal pivot of the Tone Arm. Refer to figures 25 and 26.

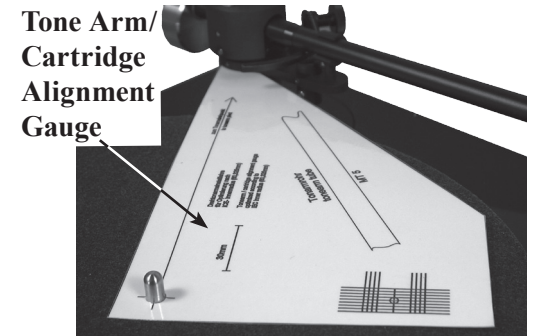

Figure 25

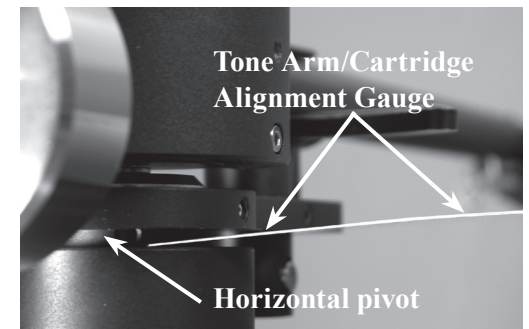

Figure 26

## Tone Arm Adjustments, con't

- With the Anti-Skate Adjustment set to minimum (refer to figure 37), carefully place the Tone Arm onto the Alignment Gauge with the diamond tip of the stylus on the center of the small circle located between the parallel lines. Refer to figures 27 and 28.

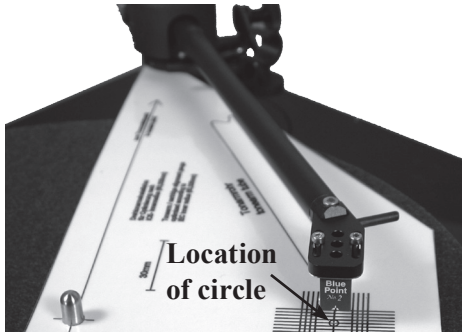

Figure 27

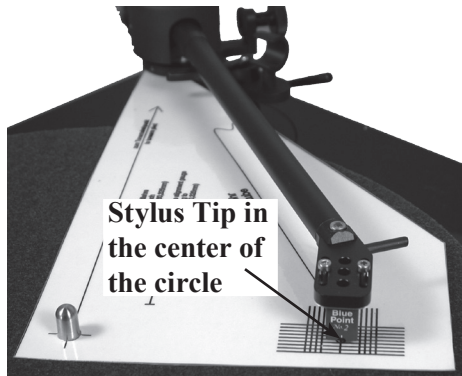

Figure 28

*Note: It may be necessary to slide the Phono Cartridge forwards or backward in the headshell to position the stylus in the center of the circle.*

- It is important the Front and Sides of the Cartridge Body line up with these parallel lines when looking down over the top of the Tone Arm. Refer to figures 28 and 29. If it is not parallel, loosen the mounting hardware securing the Phono Cartridge

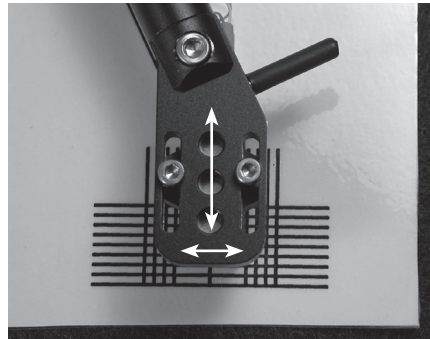

Figure 29

to the Tone Arm. Reposition the Phono Cartridge so the tip of the stylus is in the center of the small circle and the Front and Sides of the Phono Cartridge are parallel to the lines on the Alignment Gauge. Tighten up the mounting hardware and verify the correct alignment.

### Tone Arm Height

To assure the best sound reproduction, it is very important the MT5 Tone Arm is parallel to the record surface during playback. The height of the Tone Arm is adjustable to accommodate the different Phono Cartridge physical heights. To adjust for the proper Tone Arm Height, perform the following the steps:

- Release the Tone Arm from the Tone Arm Rest, place it on a record and check to see if the Tone Arm is parallel to the surface of the record. Refer to figure 30. With the Tone Arm parallel, no adjust-

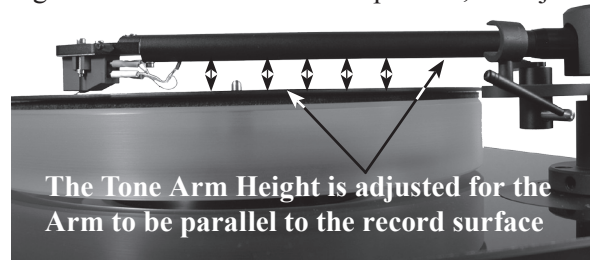

Figure 30

ment is needed and proceed to “Setting the Tracking Force Pressure”. If the Tone Arm is not parallel, note whether the rear of the Tone Arm needs to go up or down.

- With the Tone Arm secured in the Tone Arm Rest, carefully loosen the two set screws while supporting the rear of the Tone Arm. Reposition the Tone Arm based on findings in the previous step. Temporarily tighten one of the set screws. Refer to figure 31.

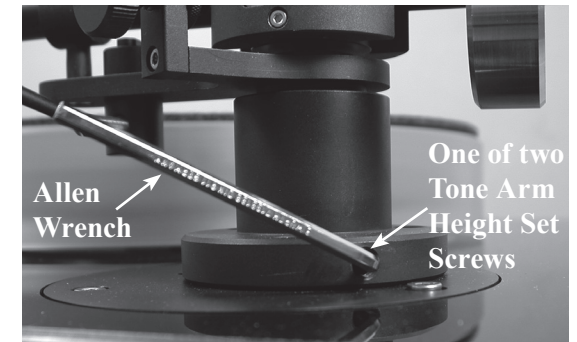

Figure 31

- Release the Tone Arm from the rest and place it on a record and check to see if the Tone Arm is now parallel. Also check to make sure the Tone Arm is parallel to the record platter and the right side of the turntable base. Refer to figure 30.
- With the Tone Arm parallel to the record surface, record platter and turntable base, tighten both set screws, which were loosened in step 2. If not, repeat steps 1, 2 and 3 until the Tone Arm is parallel.

### Setting the Tracking Force Pressure

The MT5 is supplied with a Stylus Tracking Force Gauge for checking and adjusting the Stylus Tracking Pressure. The Gauge uses the “Balance Scale” methodology for measurement. Place the Gauge on

the record mat and perpendicular to the front of the Tone Arm, with the Stylus Tip over graduation marks. Set the Anti-Skate Adjustment to minimum (refer to figure 37). Adjust the position of the Tone Arm Counterweight to establish a tracking force pressure in the middle of the recommend range from the Cartridge manufacturer as a starting place. Refer to figures 32 thru 35.

*Note: Usually, adjusting the tracking force pressure closer to the maximum setting recommend by the Cartridge Manufacturer will produce better sound with less record and stylus wear. Refer to "Trackability Adjustments" for additional information.*

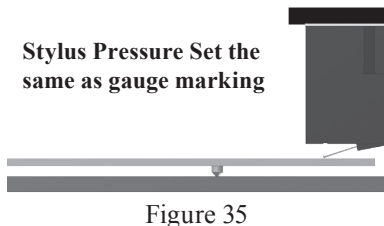
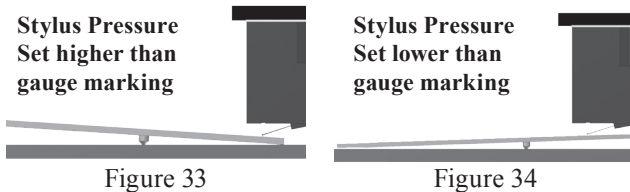
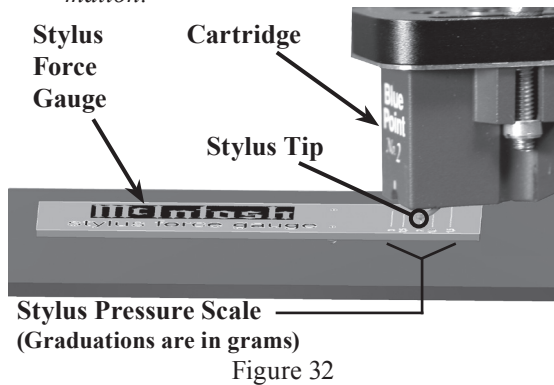

## Anti-Skating Adjustment

The MT5 has adjustable Magnetic Anti-Skating to equalize the pressure on both sides of the record groove wall, refer to "Trackability Adjustments" for additional information.

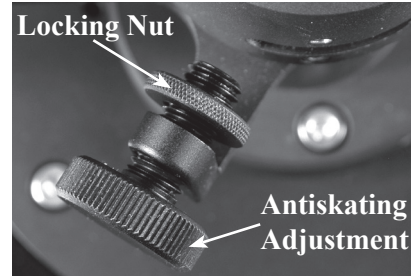

Figure 36

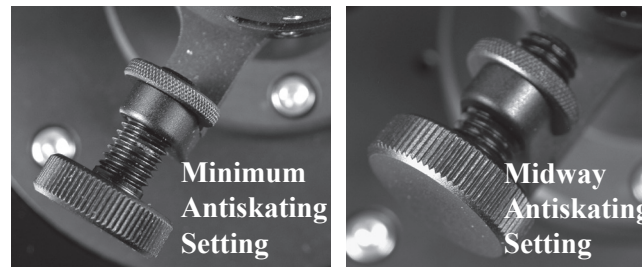

Figure 37

Figure 38

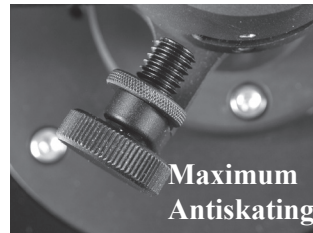

Figure 39

## Trackability Adjustments

During playback of Phonograph Recordings, the stylus assembly is subjected to all kinds of extreme operating conditions. One of those conditions is the forces constantly trying to push the stylus up and out of the grooved wall of the recording. Another condition is the uneven side to side pressure applied to the stylus as it tries to stay in contact with both sides of the groove wall of the recording. Refer to figure 40.

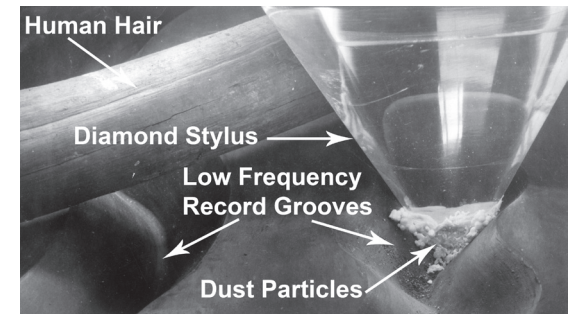

Figure 40

The Anti-Skating Adjustment permits equalizing for even side to side pressure. The correct amount of Tracking Force Pressure and Anti-Skate Pressure varies with the exact shape of the Stylus Tip and finally the audio signal (both frequency and amplitude) contained in the groove wall of the record.

To achieve good performance and the least amount of Stylus Tip/Record Groove wear is to use a Trackability Test Record. Both Tracking Force and Anti-Skate Adjustments are made as a result of listening to the test record to reduce different forms of audible distortions. Never exceed the manufacturers recommend Maximum Tracking Force Pressure Setting.

Your McIntosh Dealer, using Test Measurement Equipment and Professional Test Recordings, can achieve via adjustments, the best possible sound quality from your record collection and ensure the greatest longevity.

AUDIO OUTPUTS connect to PHONO Inputs of the Preamplifier or A/V Control Center. For specific information on the type of Phono Input to use, please refer to the next page.

POWER CONTROL REMOTE IN receives turn-on signals from a McIntosh component and switches the Front Panel Illumination On/Off.  
POWER CONTROL REMOTE OUT sends turn-on signals on to another McIntosh Component

Connect to the AC / DC Adapter supplied with the MT5 Turntable. Then connect the AC / DC Adapter to a live AC outlet. Refer to information on the Power Supply to determine the correct voltage

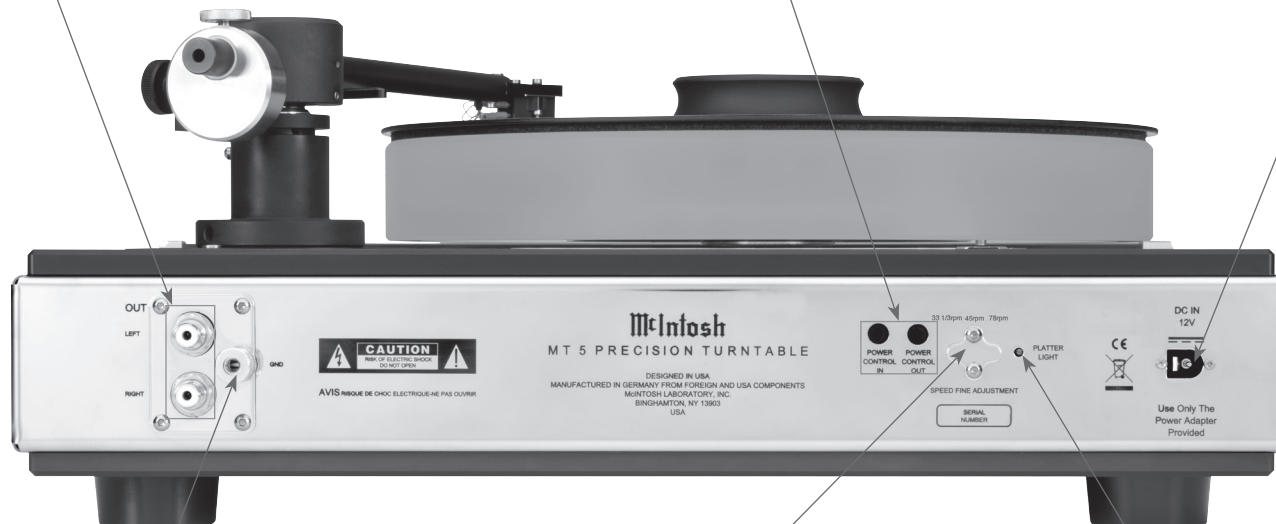

GND (Ground) connects to GND (Ground) connection on the Preamplifier or A/V Control Center

Fine speed adjustments for 33-1/3, 45 and 78 rpm. These Adjustments require special test records and precision measurement equipment to accurately set the speeds. Contact your McIntosh Dealer for assistance

PLATTER LIGHT  
Fine adjustment of the Turntable Platter Illumination level

How to Connect the Turntable

1. Connect a Power Control Cable from the MT5 POWER CONTROL IN to the POWER CONTROL MAIN Output jack of a McIntosh Preamplifier or A/V Control Center.
2. Optionally, connect a Power Control Cable from the MT5 POWER CONTROL OUT to the POWER CONTROL IN jack of a McIntosh source component.
3. Connect a wire from the MT5 GND (Ground) Post to the GND (Ground) post on the McIntosh Preamplifier or A/V Control Center.
4. Connect Audio Cables from the MT5 OUT L and R jacks to the MC (Moving Coil) Inputs on a McIntosh Preamplifier or A/V Control Center.

*Notes: 1. The MT5 Turntable with the Blue Point No. 2 High Output Moving Coil Cartridge may also be connected to a Preamplifier or A/V Control Center with a Moving Magnet Phono Input.*

2. For additional information about obtaining optimum performance from the installed phono cartridge, refer to page 17 "Phono Cartridge Loading".
3. Contact your McIntosh Dealer for additional information and assistance.

5. Connect the supplied AC / DC Adapter to the MT5 DC IN 12V socket and the Power Supply to a live AC outlet.

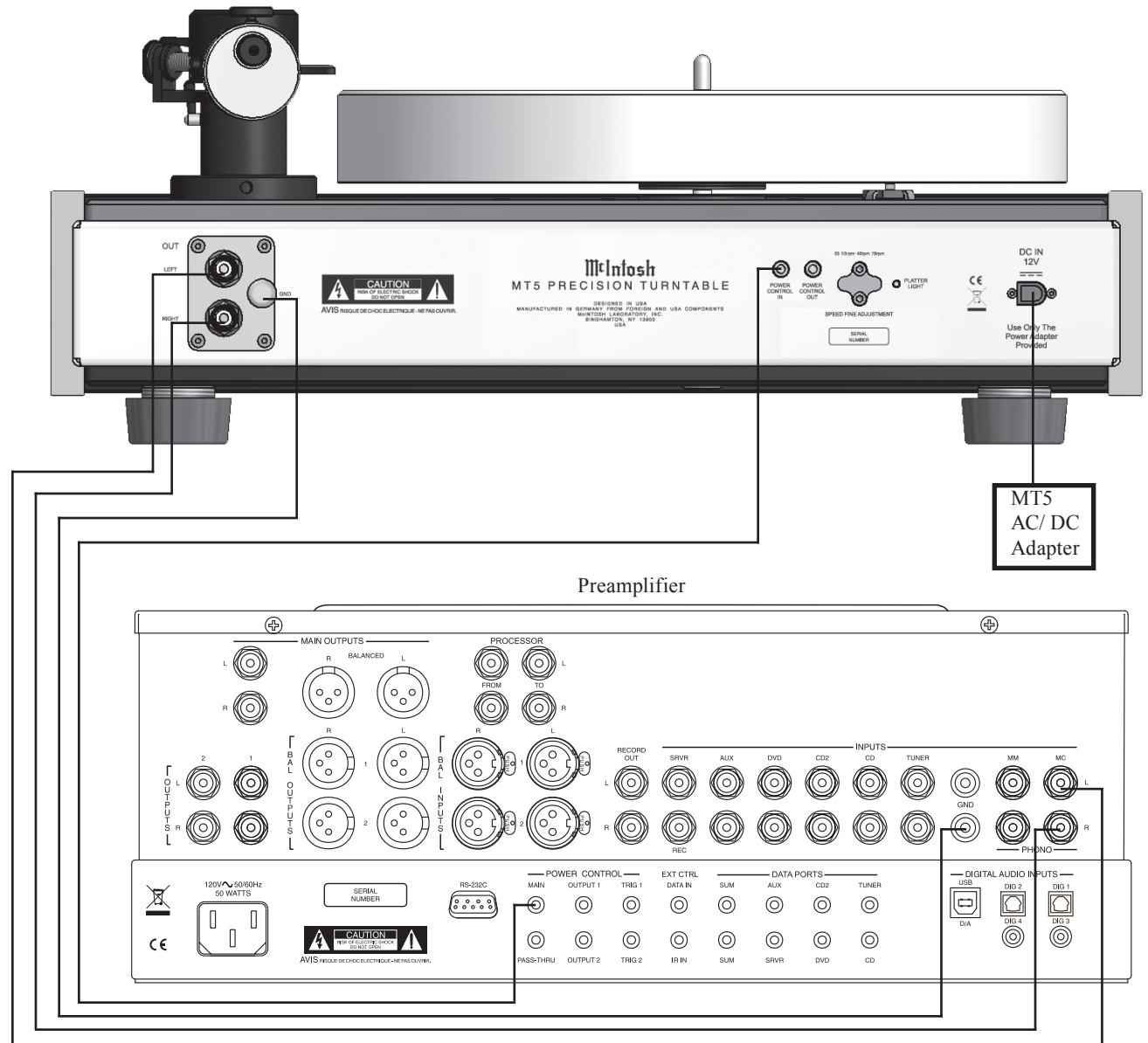

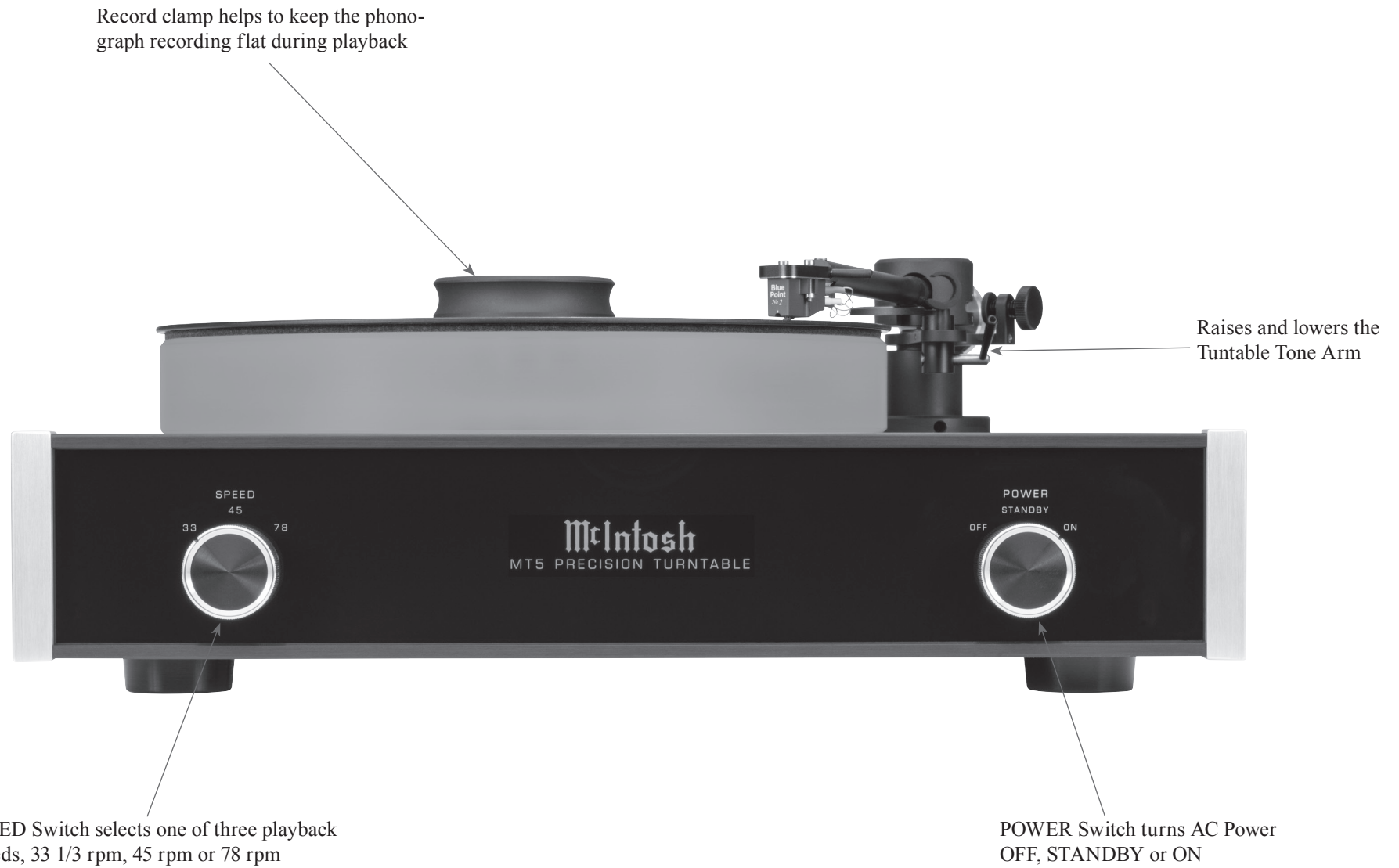



## How to Operate the Turntable

### Power Selection

Rotate the POWER Switch to select the Turntable Operation Mode desired. Refer to figure 50.

**Power Off** - The Front Panel and Turntable Platter illumination are switched OFF and there is no Turntable Platter rotation.

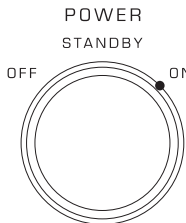

Figure 50

**Standby** - The Front Panel and Turntable Platter will illuminate when the McIntosh Preamplifier or A/V Control Center is turned On.

*Note: There must be a power control connection between the MT5 and the McIntosh Preamplifier or A/V Control Center, in order for the Standby Mode to function.*

**On** - The Front Panel and Turntable Platter illumination are Switched ON. The Turntable Platter will rotate at the selected speed.

### Speed Selection

Rotate the SPEED Switch to select the playback speed (33-1/3 rpm, 45 rpm or 78 rpm) of the phonograph record to be played. Refer to figure 51.

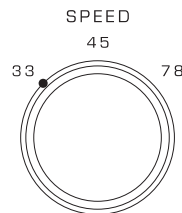

Figure 51

### Phono Cartridge Loading

For optimum performance it is important the Phono-Cartridge be connected to the correct load impedance. Refer to the respective Owner's Manual for the Preamplifier, Integrated Amplifier or Audio/Video Control Center used with the MT5 for additional information.

The Blue Point #2 Cartridge supplied with the MT5 Turntable is a Moving Coil Type with High Output. Set the load resistance to 1,000 Ohms (or the closest available value).

### Tone Arm Lift

The McIntosh MT5 Precision Turntable has a Tone Arm Lift Mechanism for safe placement and removal of the cartridge stylus on the phonograph record. Perform the following steps:

1. Push on the top part of the Tone Arm Lift Lever towards the rear of the turntable. Refer to figure 52.

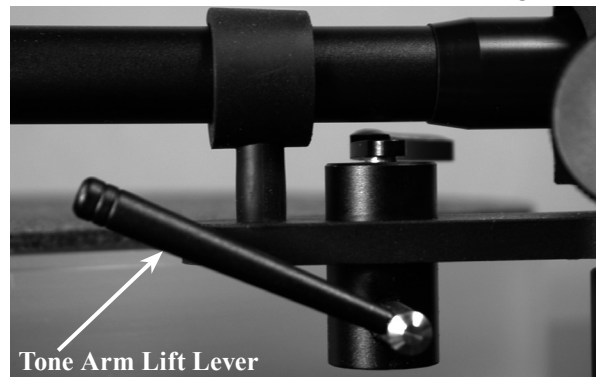

Figure 52

2. Release the Tone Arm from the Tone Arm Holder. Refer to figure 53.

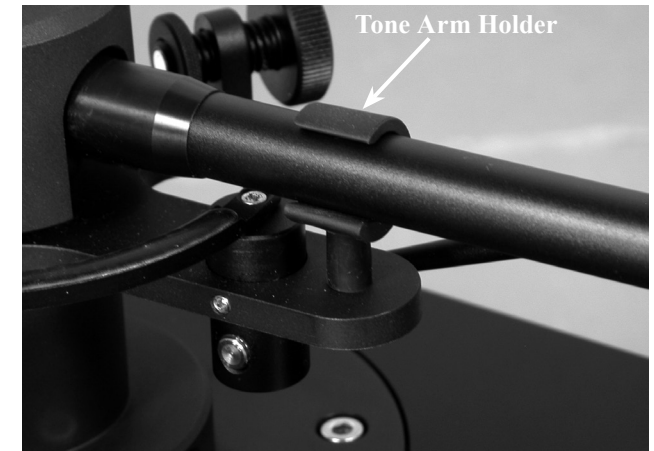

Figure 53

3. Position the Tone Arm over the desired spot of the Phonograph record.
4. Pull on the top part of the Tone Arm Lift Lever towards the front of the turntable to begin playback.



**Blue Point No.2 Cartridge Specifications**

**Cartridge Type**

Moving Coil, High Output

**Output Level**

2.5 mV at 5 cm/s

**Load Impedance**

1000 ohms recommended (Preamp MC Input)

**Frequency Response**

20Hz to 50,000Hz

**Channel Separation**

35dB at 1kHz

**Channel Balance**

Less than 0.5 dB at 1kHz

**Tracking Force Range**

1.6 to 2.0 grams

**Recommended Tracking Force**

2.0 grams

**Compliance**

15 x 10<sup>-6</sup> cm/dyne

**Total Mass**

6.3 grams

**Stylus**

Elliptical Diamond

**Cantilever Material**

Aluminum

**MT5 Turntable Specifications**

**Playback Speeds**

33 1/3 rpm, 45 rpm and 78 rpm

**Motor Type**

DC Stainless Steel Brushes

**Speed Control**

Servo System

**General Specifications**

**Overall Dimensions**

Width is 17-1/2 inches (44.5cm)

Height is 7 inches (17.8cm) (without Dust Cover)

*Note: The Turntable Height is affected by the type of Cartridge installed and the required Tone Arm Height Adjustment.*

Height is 7-1/2 inches (19.0cm) (with Dust Cover)

Depth is 19 inches (48.3cm) (including the Front Panel, Knobs and Cables)

**Weight**

31.5 pounds (14.3Kg) net, 38 pounds (17.2Kg) in shipping carton

**Shipping Carton Dimensions**

Width is 21-1/2 inches (54.6cm)

Depth is 20 inches (50.8cm)

Height is 15 inches (38.1cm)

**Packing Instructions**

In the event it is necessary to repack the equipment for shipment, the equipment must be packed exactly as shown below. It is very important the four feet are still attached to the bottom of the equipment. This will ensure the proper equipment location on the Platter foam pads. Failure to do this will result in shipping damage.

Use the original shipping carton and interior parts only if they are all in good serviceable condition. If a shipping carton or any of the interior part(s) are needed, please call or write Customer Service Department of McIntosh Laboratory. Refer to page 3. Please refer to the Part List below for the correct part numbers.

Quantity	Part Number	Description
1	310528SP	Shipping carton only
1	310533SP	Top foam pad
1	310532SP	Cover foam pad
1	310531SP	Accessory pack foam
2	310530SP	Turntable foam
2	310529SP	Platter foam pad

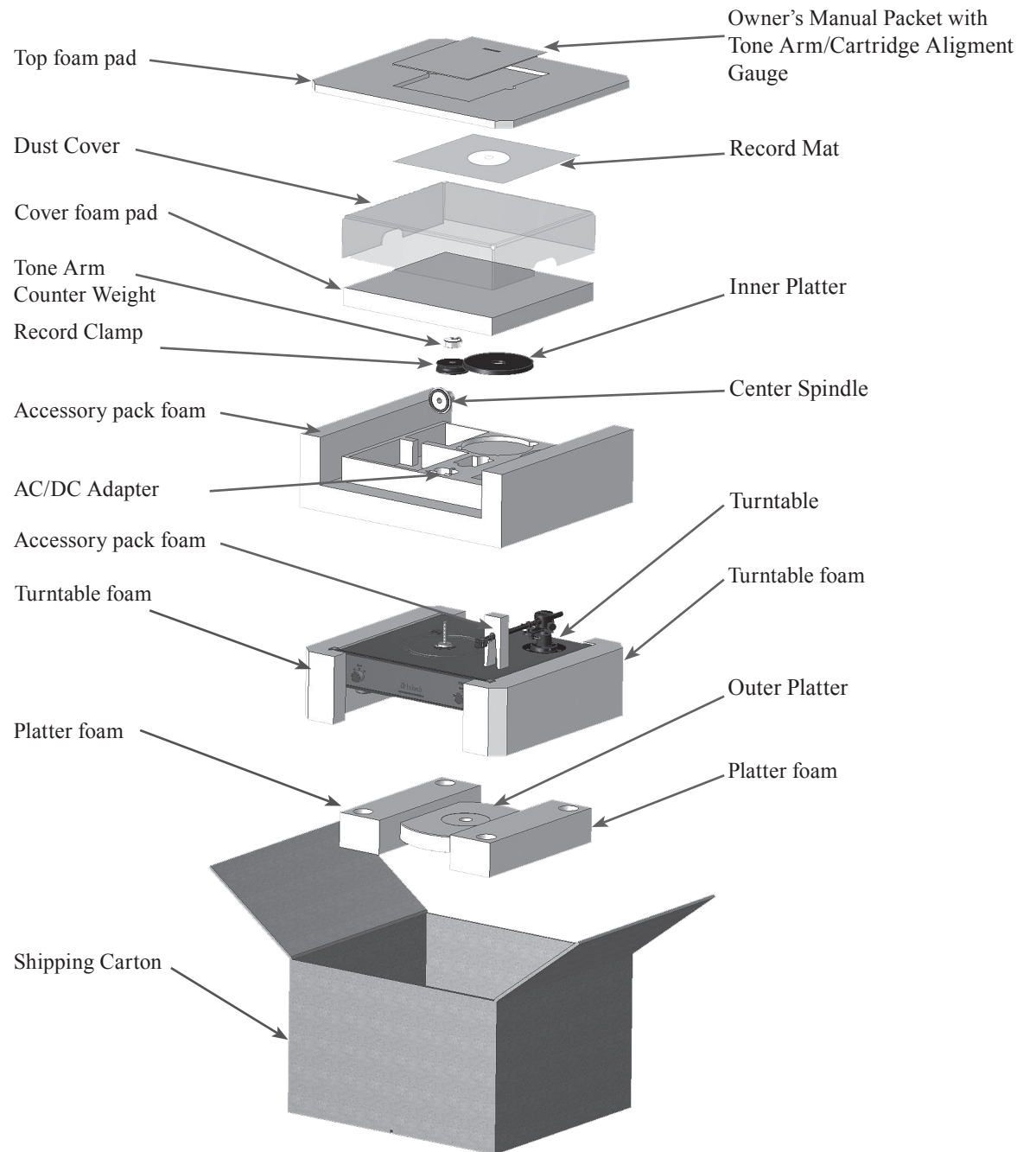



McIntosh Laboratory, Inc.  
2 Chambers Street  
Binghamton, NY 13903  
[www.mcintoshlabs.com](http://www.mcintoshlabs.com)

The continuous improvement of its products is the policy of McIntosh Laboratory Incorporated who reserve the right to improve design without notice.  
Printed in the U.S.A.